



**IJMRBS**

ISSN: 2319-345X

# International Journal of Management Research and Business Strategy

[www.ijmrbs.org](http://www.ijmrbs.org)



E-mail

[editor@ijmrbs.org](mailto:editor@ijmrbs.org)

[editor.ijmrbs@gmail.com](mailto:editor.ijmrbs@gmail.com)

# Power Factor Correction of Three-Phase PWM AC Chopper Fed Induction Motor Drive System Using HBCC Technique

M Saritha<sup>1</sup>, B Leela radhika<sup>2</sup>, M Pavan kumar<sup>3</sup>

<sup>1</sup>Associate Professor, Department of EEE, BRILLIANT GRAMMAR SCHOOL EDUCATIONAL SOCIETY'S GROUP OF INSTITUTIONS-INTEGRATED CAMPUS Abdullapurmet (V), Abdullapurmet (M), R.R Dt. Hyderabad-501505

<sup>2</sup>Assistant Professor, Department of EEE, BRILLIANT GRAMMAR SCHOOL EDUCATIONAL SOCIETY'S GROUP OF INSTITUTIONS-INTEGRATED CAMPUS Abdullapurmet (V), Abdullapurmet (M), R.R Dt. Hyderabad-501505

<sup>3</sup>UG Student, Department of EEE, BRILLIANT GRAMMAR SCHOOL EDUCATIONAL SOCIETY'S GROUP OF INSTITUTIONS-INTEGRATED CAMPUS Abdullapurmet (V), Abdullapurmet (M), R.R Dt. Hyderabad.

## *Article Info*

*Received: 19-11-2022*

*Revised: 11-12-2022*

*Accepted: 15-01-2023*

## **ABSTRACT:**

The paper provides modeling and simulation of a single-phase AC-DC hybrid microgrid's power flow control strategy (HMG). The recommended system topology for HMG includes an ordinary H-Bridge inverter/rectifier, a full bridge IGBT structure, two air conditioners, and DC areas that are separated by a bidirectional interlinking converter (BIC). Based on the DQ change principle, two power control loops and one voltage control loop (Vdc) supply the BIC's changing pattern. The transmission of active and reactive power between the HMG and the public a/c Grid is permitted by this control approach in a controlled manner. Additionally, by utilising the bidirectional converter in correcting or inverting settings, this is carried out in both instructions. Matlab Simulink is used to execute and evaluate the simulation design.

***Key words: micro grid, HMG, Vdc, DQ, and BIC.***

## I ANNOTATION

he injection techniques to assist in power factor correction/compensation (PFC) for the local AC circulation public grid at the point of customary combining (PCC) is another critical component of modern HMG. Due to the constrained availability of reactive power, a single family HMG may have to make a small payment for PFC at the PCC for a local public grid. An increased number of HMG collaborating using this method in a specific local audience might indicate a far more significant impact on the high quality of the power dispersed by making up the power variable at the common combining point. The DQ synchronous reference frame control for single-phase systems is proposed in recommendations [7], [8], [9], and [10] by converting the AC signals directly into DC signals for the most dependable sort of processing. This upgrade is being put to use in certain obvious applications by using three control loops to regulate the output DC voltage and active-reactive power. In comparison to previous applications, the current job demonstrates the method's ability to modify the stage of the current feed or injection from the AC Grid in order to compensate for or correct the power factor at PCC. This method can operate in either rectifier or inverter modes.

Lately According to the poll, the average Indian consumes 1075 kilowatt hours (kwh) of electricity annually, and 85% of that energy is generated using fossil fuels as its main energy source, which results in significant amounts of carbon dioxide emissions that contribute to global warming. Renewable resource sources, however, have emerged as a generous replacement that is offered free, environmentally friendly, and has a reduced amount of operational and maintenance costs due to the increase in demand for electricity, a lack of reserve, and the training value of conventional sources such as firewood and petroleum. The increased distribution generation of several modern technologies of renewable resource resources as solar, wind, tidal, biomass, and geothermal (DG). The extensive use of DGs will provide challenges to the power system network, and a microgrid, which has received a lot of attention globally, is a key

solution to this problem. Currently, microgrids are divided into three categories: air conditioning microgrids, DC microgrids, and HACDC microgrids due to the generation of electrical energy in both (A/C and DC) forms with the use of various renewables. In AC microgrids, the AC generating resources are directly connected utilising power digital interfaces, while the DC generating resources, such as PV and Fuel Cells, are converted to AC with the use of DC/AC converters. In contrast, air conditioning generating sources used in DC microgrids are converted to DC using AC/DC converters. However, these numerous conversions result in losses. Hybrid microgrid provides a quick fix for the issues mentioned

above, as it minimises multiple conversions and also decreases losses. Electric power and system homogeneity are the two significant and important components of crossbreed systems that are grouped together. The best potential blueprint for the system should be consistent and cost-effective, and it can be done with the help of the right system apparatus selection. Therefore, the selection of a capable and cost-effective HACDC microgrid system requires the use of an optimum sizing technique. The hybrid microgrid's basic design, which includes solar energy (PV), wind energy (WT), battery energy storage, and other components related to the energy grid, is shown in Figure 1

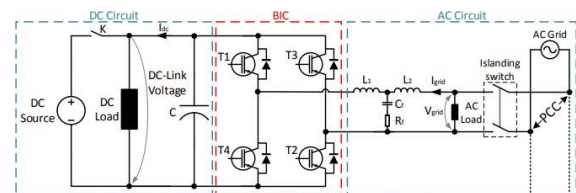

**Fig.1. Block diagram.**

## 2. LITERATURE SURVEY

The bidirectional interlinking converter is used to distinguish between the two AC and DC circuits in the residential single-phase hybrid micro-grid, as shown

in Figure 1. (BIC). The AC grid, the point of common coupling (PCC), the islanding switch, the AC load, and an LCL passive filter are all components of the AC circuit

#### CURRENT SYSTEM:

The invention of electricity, which is used for all kinds of functions in modern society, is the greatest gift that science has ever given to humanity. However, there has been a paradigm shift in the generation of electrical energy recently, moving away from the idea of using large producing plants and toward smaller generating units connected to distribution systems in the form of microgrids using renewable energy sources. The usage of renewable energy is increasing globally, and these alternative energy sources can provide civilization with electrical energy that is pollution-free. There are still many difficulties in operating and controlling isolated and grid-connected microgrids that are configured in both AC and DC, despite the fact that these are new centers and units

with declining costs. Hybrid AC/DC Microgrids (HAC/DC) were created to combine the advantages of microgrids that are both AC and DC. **SYSTEM SUGGESTED:**

The bidirectional interlinking converter is used to distinguish between the two AC and DC circuits in the residential single-phase hybrid micro-grid, as shown in Figure 1. (BIC). The AC grid, the point of common coupling (PCC), the islanding switch, the AC load, and an LCL passive filter are all components of the AC circuit. The capacitive filter (C), the DC load, and/or the storage component are all components of the DC circuit (DC Source). Transfer from/to the AC and DC circuits is ensured by the bidirectional interlinking H-bridge converter (BIC). Three distinct operation instances are used to determine the energy management for the bidirectional interlinking converter. The scenario for the first two cases allows

for the control of reactive power, and the third case emphasizes running at unity power factor. All of the electrical DC consumers are supplied with electricity thanks to the Rectifier's operating mode (case 1), which enables the transfer of electrical energy from the AC Grid to the DC-Grid. The AC load is powered directly by the AC grid and the DC load, and a power electronic converter interfaces it with the DC-link voltage. In scenario 2, the inverter's working mode supplies the DC load directly from the DC source while simultaneously allowing energy to pass through the AC grid to the AC load via the interlinking converter. The AC-DC hybrid microgrid is islanding during an unforeseen event (defect incidence, quality condition failure, independent micro-grid operation), unlike the prior example, in which there is a physical link to the AC public grid. The DC Source in this instance secures the power supply for both types of consumers.

#### MANAGEMENT AND OPERATING

The input current, input voltage, DC voltage, and DC current

well. The single-phase DQ transformation is used to acquire the  $V_d$  and  $V_q$  voltages as well as the  $I_d$  and  $I_q$  currents in the DQ rotation references frame for the  $V_g$  and  $I_g$  signals. The DC voltage ( $V_{dc}$  ref), the active power ( $P_{ref}$ ), which is obtained using the current and voltage of the DC-link, and the reactive power ( $Q_{ref}$ ), which is determined by the AC public grid, are the references control signals. The PWM signals for switching the interlinking converter transistors are the control system's outputs.

In the first control loop, the DC voltage ( $V_{dc}$ ) is regulated in order to provide the necessary reference for the  $I_{dc}$  ref DC current. This is done by comparing the DC voltage ( $V_{dc}$ ) to the necessary reference ( $V_{dc.ref}$ ), which results in a steady state mistake that the PI1 controller then corrects for. The measured values of the active ( $P$ ) and reactive ( $Q$ ) powers based on equation are the outputs of the P-Q calculation block

(1). These signals will be compared to the power control reference values ( $P_{ref}$ ,  $Q_{ref}$ ), and the PI2 and PI3 controllers will correct the results by returning the reference values for the two current control loops ( $I_d$  ref,  $I_q$  ref) [14]. The signals ( $V_{dm}$ ,  $V_{qm}$ ) that the PI4 and PI5 controllers output indicate the

signals that, after being transformed, will be the inputs for the sinusoidal PWM generator (PWM).

$$\begin{cases} P = V_d I_d + V_q I_q \\ Q = V_d I_q - V_q I_d \end{cases}$$

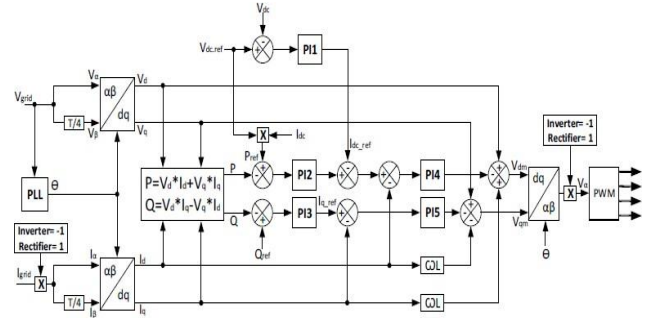

**Fig.2. Control strategy schematic.**

The simulation model (Fig. 2) of single- phase AC-DC Hybrid Micro-Grid was simulated in Matlab/Simulink software and it is based on the HMG topology (Fig. 1) and control structure (Fig. 2). In case 2 and 3 (inverter mode) the measured value of the  $I_{grid}$  and the modulating signal  $V_{\square}$  must be shifted with 180 degrees by multiplying them with constant -1 (Fig. 2). In the case 1 (Rectifier operating mode) the  $I_{grid}$  is the same with the measured value and the  $V_{\square}$  is the related signal by dq to  $\alpha\beta$  transformation block. The  $V_{\square}$  is not used for PWM modulating and is ignored.

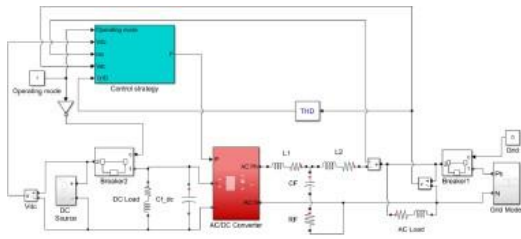

**Fig. HMG Matlab/Simulink model.**

The LCL filter was tuned using the passive method which consists in adding a series damping resistance (RF) in parallel with capacitor filter (CF). The figure 4 shows the effects in frequency domain of the LCL passive damping compared to the LCL filter without damping.

### 3 SIMULATION RESULTS

The instantaneous power control is studied for each case described in second section of this paper. Figure show the simulation results where a comparison is done between the AC grid currents (Igrid) at three situations regarding the reactive power control (resistive, inductive or capacitive character), while the Figure shows the islanding case.

#### RECTIFIER MODE:

Igrid1- current for  $P=2000$  [W],  $Q=0$  [var],  $\cos \Theta=1$ . Igrid2-current for  $P=2000$  [W],  $Q=1000$  [var],  $\cos \Theta=0.89$ . Igrid3-current for  $P=2000$  [W],  $Q= -1000$  [var],  $\cos \Theta=0.89$ . 457

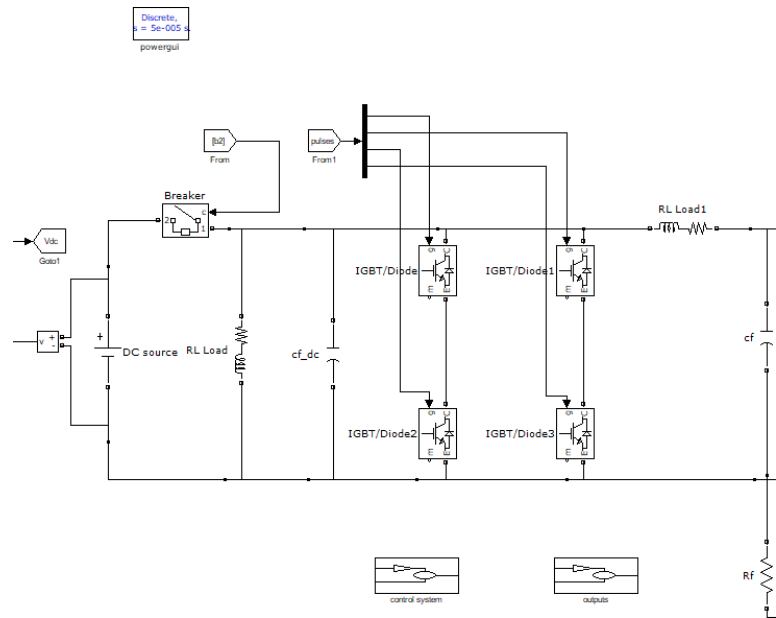

#### RECTIFIER MODE:

##### CASE 1:

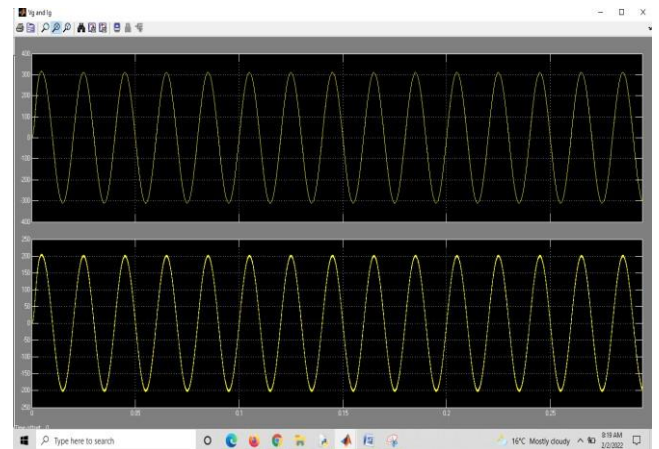

##### CASE 2:



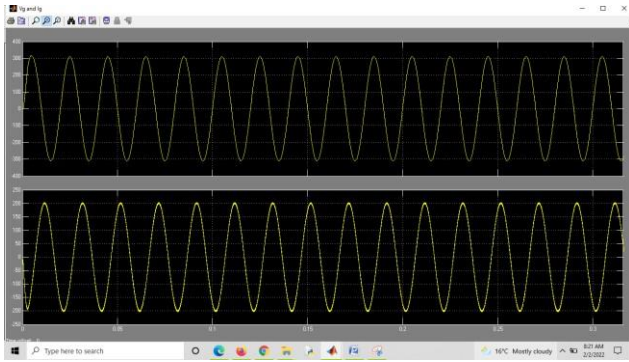

**CASE 3:**

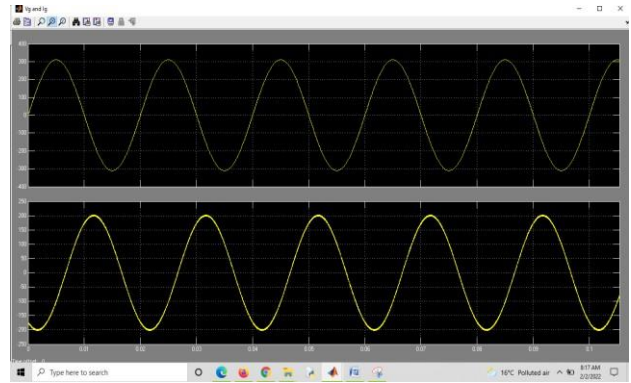

**CASE 3:**

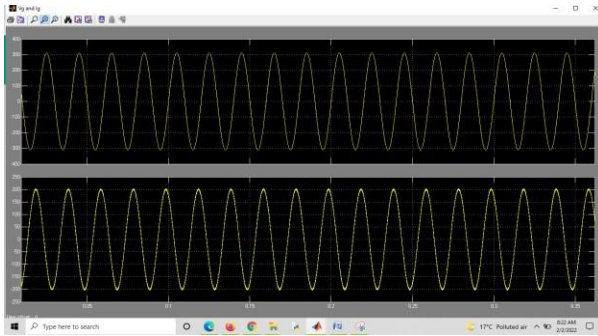

**INVERTER MODE:**

**CASE 1:**

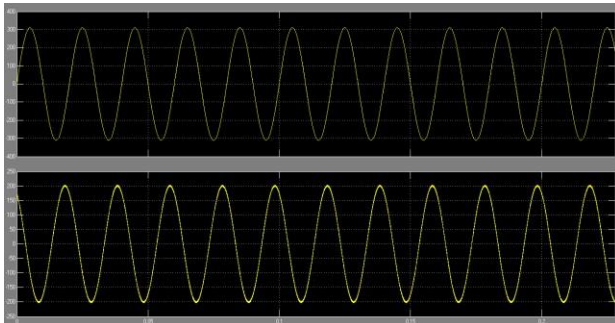
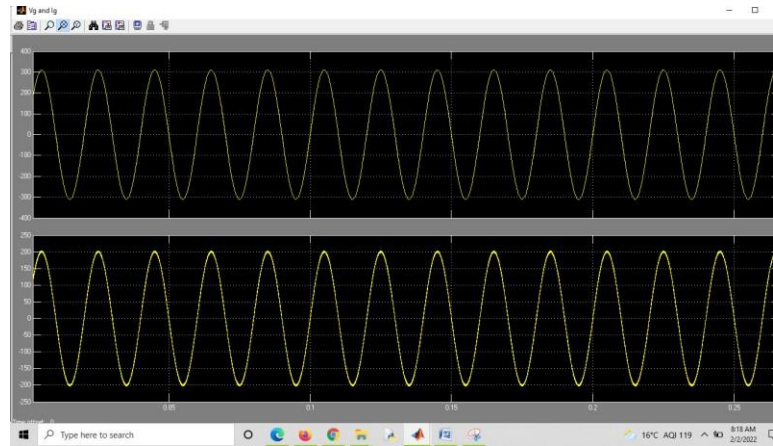

**CASE 2:**

**ISLANDING MODE:**

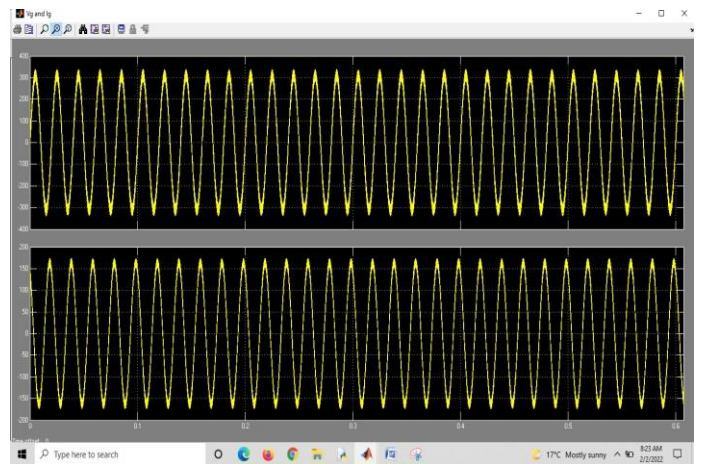

**PAPER EXTENTION WITH SOLAR:**



**RECTIFIER MODE:**

## CONCLUSION

In a single-phase AC-DC residential hybrid microgrid, this paper describes the simulation of an active and reactive power regulation method for a bidirectional interlinking converter. The work is grounded in power factor compensation at the point of common coupling with the AC power grid. Reactive power is managed regardless of the direction of power flow (rectifier-figure, inverter-figure, islanding figure), making it possible to calculate the power factor in accordance with the specifications set at the AC distribution grid. The Hybrid Micro-Grid system described in this paper is to be put into practice in future work.

## REFERANCES

[1] Fatemeh Ghalavand, Ibrahim Al-Omari, Hossine Kazemi Karegar and Hadis Karimipour, "Hybrid Islanding Detection for AC/DC Network Using DC-link Voltage," IEEE International Conference on Smart Energy Grid Engineering (SEGE), Oshawa, Canada, 2018.

[2] Gongxin Qi, Alian Chen and Jie Chen, "Improved Control Strategy of Interlinking Converters With Synchronous Generator Characteristic in Islanded Hybrid AC/DC Microgrid," *CPSS TRANSACTIONS ON POWER ELECTRONICS AND*

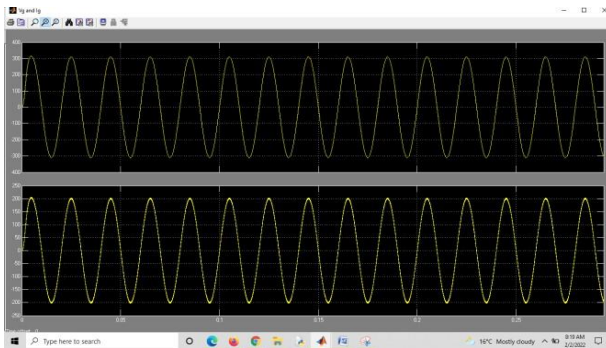
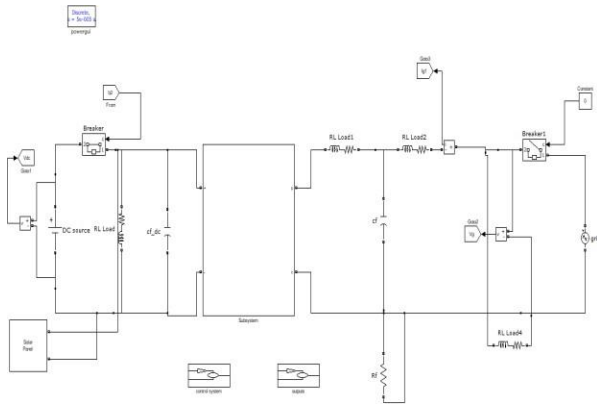

## INVERTER MODE:

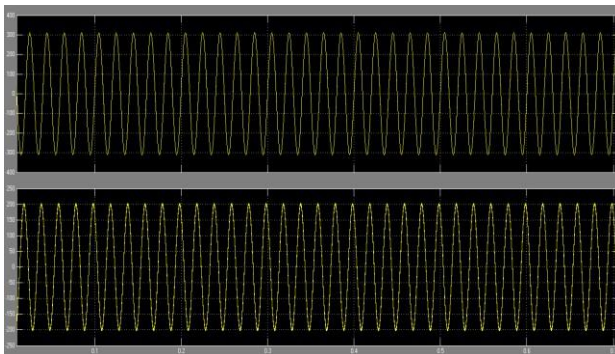
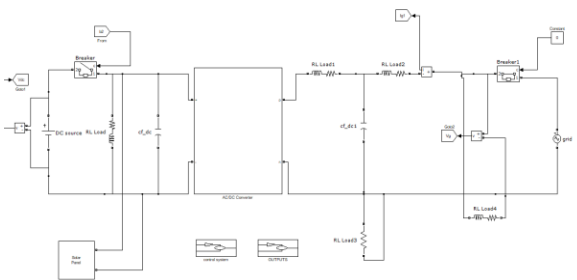

*APPLICATIONS*, vol. VOL. 2, no. NO. 2, JUNE 2017.

[3] A. Hina Fathima, N. Prabakaran, K. Palanisamy, Akhtar Kalam, Saad Mekhilef and Jackson. J. Justo, *Hybrid-Renewable Energy Systems in Microgrids: Integration, Developments and Control*, Woodhead Publishing; 1 edition (June 5, 2018), 2018.

[4] ON Semiconductor, *Power Factor Correction (PFC) Handbook. Choosing the Right Power Controller Solution*.

[5] ABB, *Power Factor Correction and Harmonic Filtering in Electrical Plants*, Technical Application Paper., 2008.

[6] Etienne TISON and Schneider Electric S.A, *Electrical installation guide: According to IEC international standards*, 2016.

[7] Nathan Weise, *DQ Current Control of a Bidirectional, Isolated, Single-Stage AC-DC Converter for Vehicle-to-Grid Applications*, 2013.

[8] U.A. Miranda, M. Aredes and L.G.B. Rolim, *A DQ Synchronous Reference Frame Control for Single-Phase Converters*.

[9] Xing Wan, Jie Ren, Tian Wan, Shi Jing, Sinian Xiong and Jiayu Guo, "A Control

Strategy of Single Phase Voltage Source PWM Rectifier under Rotating Coordinate," in *International Conference on Power and Renewable Energy*, 2017.

[10] Yicheng Liao, Zhigang Liu, Han Zhang and Bo Wen, "Low- Frequency Stability Analysis of Single-Phase System With dq-Frame Impedance Approach—Part I: Impedance Modeling and Verification," *IEEE TRANSACTIONS ON INDUSTRY APPLICATIONS*, VOL. 54, NO. 5, 2018.